

MİTES MTS-20 EN FUEL METER

TECHNICAL DATA

- ◆ **Product Type:** Gasoline-Kerosene-Diesel
- ◆ **Flow Rate (Min):** 55 lpm
- ◆ **Flow Rate (Max):** 550 lpm
- ◆ **Operation Temperature:** -40°C / +70°C
- ◆ **Counter Register:** Electronic-MC 02
- ◆ **Weight:** 26 kg
- ◆ **Dimensions (WLH):** 440×490×405 mm
- ◆ **Flange Diameter:** 2"
- ◆ **Meter Body:** Cast Iron (PIG GG25)

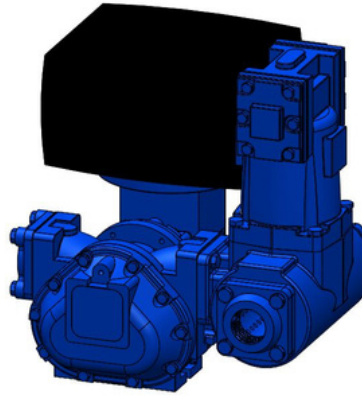
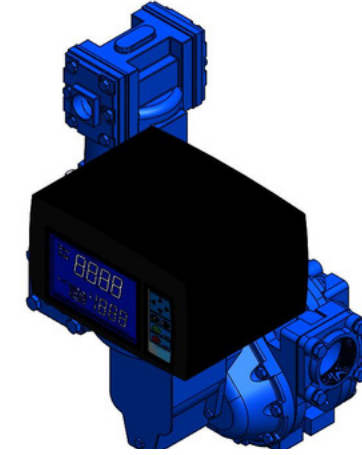

The MTS-20 model fuel meter, produced by the MİTES brand, one of the MLB Group companies, is a meter with positive displacement and high measurement accuracy. It is designed to be used safely wherever fuel oil measurement is required. When the usage and maintenance instructions are followed, it can be used for many years without any problems and accurate measurements can be taken.

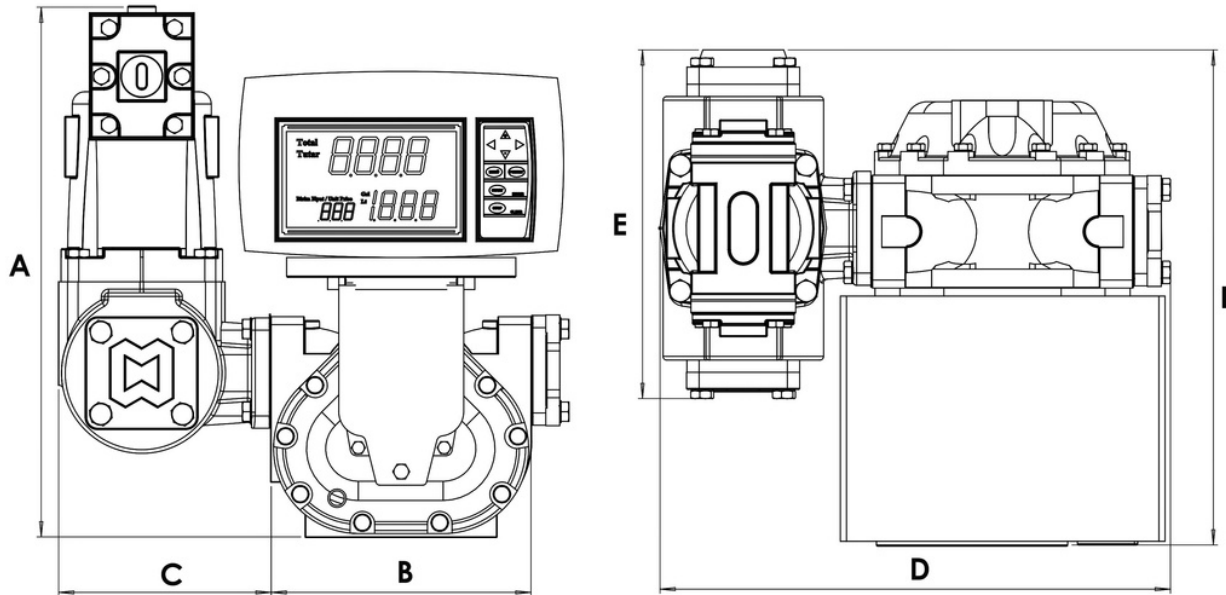

DIMENSIONS (mm)	A	B	C	D	E	F
	405	250	175	490	285	440